

Modus

Soft atmospheres

DESIGN
Pedrali R&D, 2010

EN — Modus is a new innovative collection of upholstered modular seatings, designed to guarantee absolute flexibility during assembly and installation phases. Linear, corner, double-seating and back-to-back compositions allow several custom made solutions.

IT — Modus è un'innovativa collezione di sedute modulari imbottite, progettata per garantire un'assoluta flessibilità in fase di assemblaggio e installazione. La composizione dei moduli lineari, bifacciali e angolari permette di creare varie configurazioni d'arredo.



DINING



Modular seating seduta modulare Modus
Armchair poltrona Vic
Table tavolo T85
Lighting lampada L001

Seating / Sedute

DINING



Modular seating seduta modulare Modus
Armchair poltrona Osaka
Side chair sedia Osaka
Table tavolo T85
Lighting lampada L001

MODUS

Modular seating Seduta modulare

Laminate or Fenix®
shelf with MDF core
Mensola in laminato
o Fenix® con anima in MDF





Sky Italia

Milan, Italy

Project: Office

Products: Modus modular seating,
Grace armchair, Arki-Table



MODUS

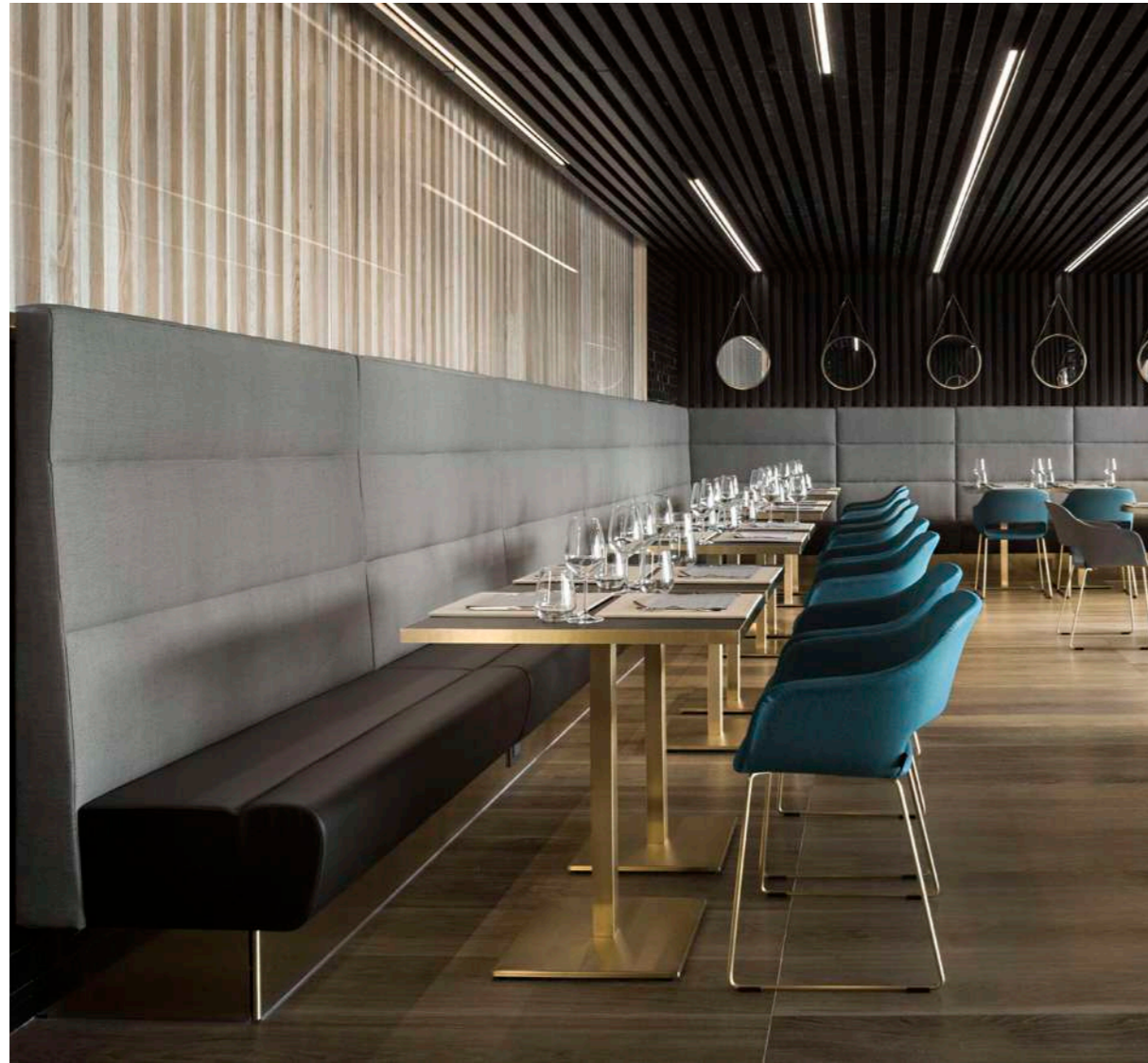

Kilometro Rosso

Bergamo, Italy

Project: Company Canteen

Products: Babila armchair, T86 table, Modus modular seating

MDL_110*

Upholstered linear modular seating, aluminium baseboard

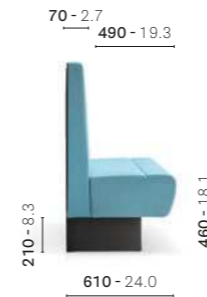

MDL_110_L100*

Upholstered linear modular seating, aluminium baseboard



MDL_140*

Upholstered linear modular seating, aluminium baseboard

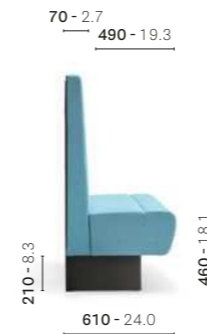

MDL_140_L100*

Upholstered linear modular seating, aluminium baseboard



MDL_175*

Upholstered linear modular seating, aluminium baseboard

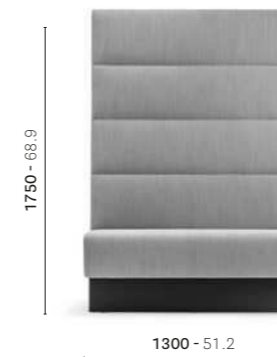

MDL_175_L100*

Upholstered linear modular seating, aluminium baseboard

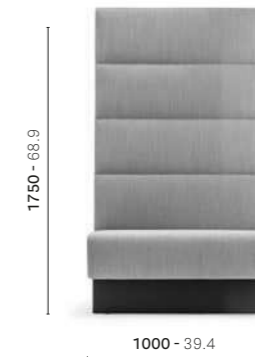

*Free standing / Autoportante



MDL_240

Upholstered linear modular seating, aluminium baseboard



MDL_240_L100

Upholstered linear modular seating, aluminium baseboard

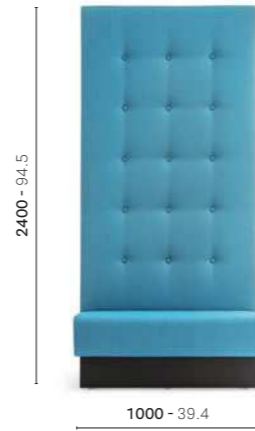

MDB_175*

Upholstered back to back modular seating, aluminium baseboard

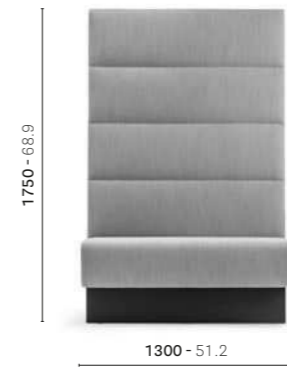

MDB_175_L100*

Upholstered back to back modular seating, aluminium baseboard

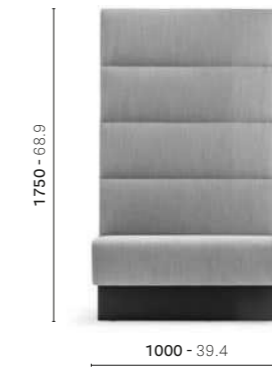

MDB_110*

Upholstered back to back modular seating, aluminium baseboard

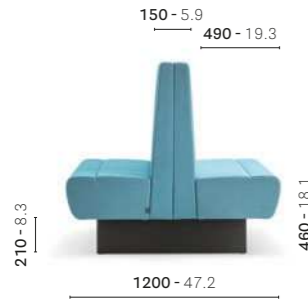

MDB_110_L100*

Upholstered back to back modular seating, aluminium baseboard



MDA_110*

Upholstered corner modular seating, aluminium baseboard

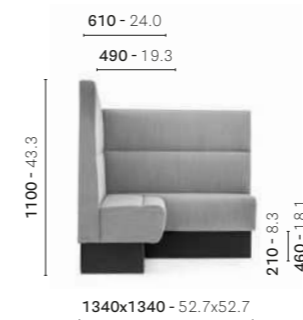

MDA_140*

Upholstered corner modular seating, aluminium baseboard



MDA_175*

Upholstered corner modular seating, aluminium baseboard



MDA_240

Upholstered corner modular seating, aluminium baseboard



MDB_140*

Upholstered back to back modular seating, aluminium baseboard

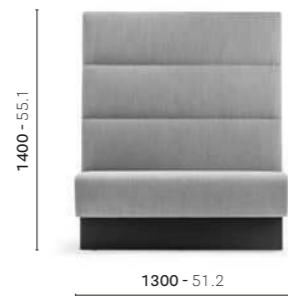
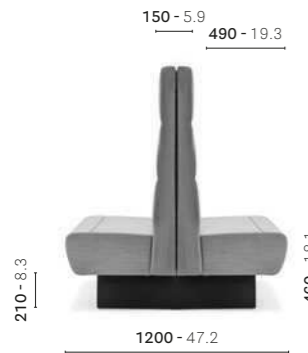

MDB_140_L100*

Upholstered back to back modular seating, aluminium baseboard

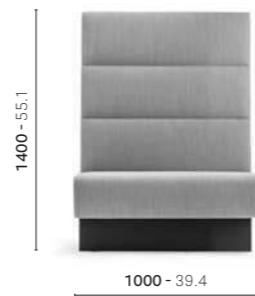

MDAB_110*

Upholstered corner back to back modular seating, aluminium baseboard



MDAB_140*

Upholstered corner back to back modular seating, aluminium baseboard



*Free standing / Autoportante

*Free standing / Autoportante

MDAB_175*

Upholstered corner back to back modular seating, aluminium baseboard



custom made sized / misura su richiesta

MD5

Backside laminate or upholstered panel
Pannello posteriore in laminato o imbottito
THICKNESS: 30 - 1.18

MDP_110*

Upholstered linear modular seating, aluminium baseboard

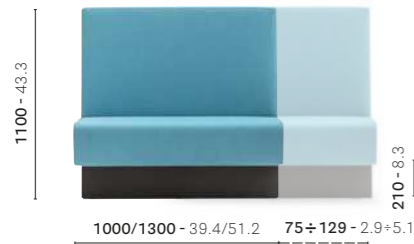

MDP_140*

Upholstered linear modular seating, aluminium baseboard

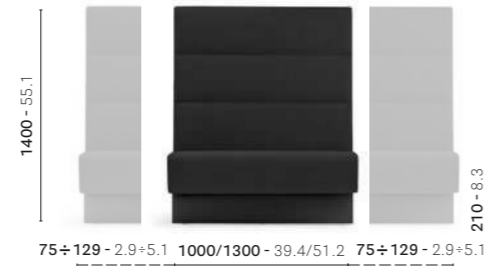

MDP_175*

Upholstered linear modular seating, aluminium baseboard

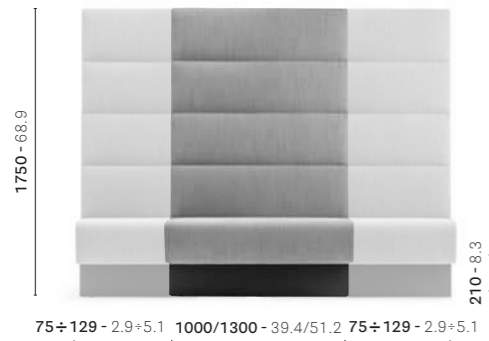

MDP_240

Upholstered linear modular seating, aluminium baseboard

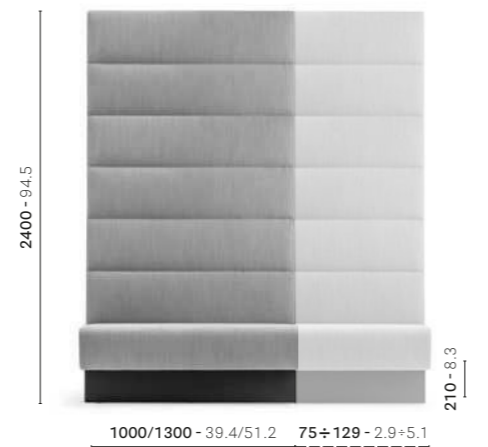

*Free standing / Autoportante

MODUS 2.0

MD/2L_110*

Upholstered linear modular seating, aluminium baseboard

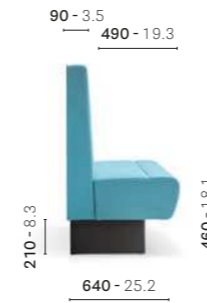

MD/2L_110_L100*

Upholstered linear modular seating, aluminium baseboard

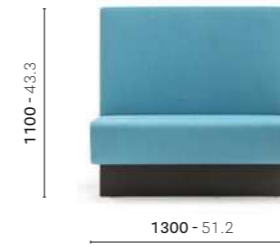

MD/2L_140*

Upholstered linear modular seating, aluminium baseboard

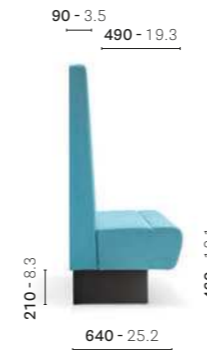

MD/2A_110*

Upholstered corner modular seating, aluminium baseboard

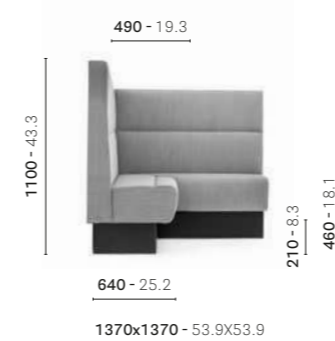

MD/2A_140*

Upholstered corner modular seating, aluminium baseboard

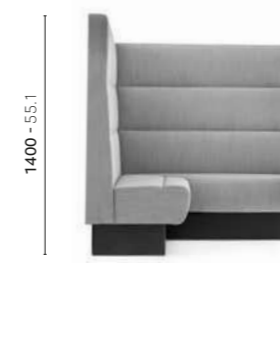

K_MD/2L

Back shelf for linear version bench
Mensola posteriore per panca lineare
THICKNESS: 40 - 1.57

K_MD/2A

Back shelf for corner unit bench
Mensola posteriore per panca angolare
THICKNESS: 40 - 1.57

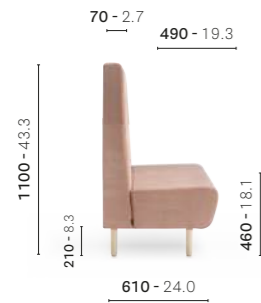

MDWL_110
Upholstered linear modular seating, solid ash wood legs



MDWL_110_L100
Upholstered linear modular seating, solid ash wood legs



MDWL_140
Upholstered linear modular seating, solid ash wood legs



MDWL_140_L100
Upholstered linear modular seating, solid ash wood legs

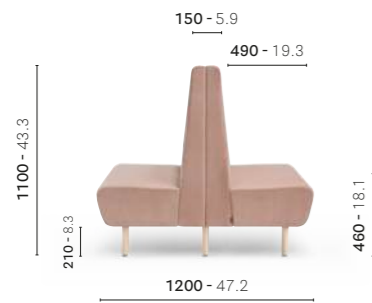

MDWB_110
Upholstered linear modular seating, solid ash wood legs



MDWB_110_L100
Upholstered linear modular seating, solid ash wood legs

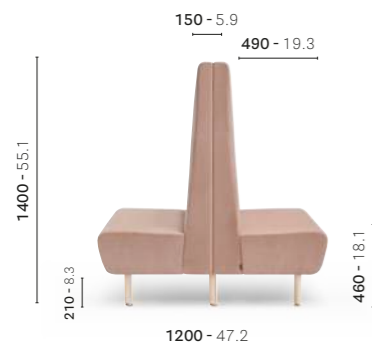

MDWB_140
Upholstered linear modular seating, solid ash wood legs



MDWB_140_L100
Upholstered linear modular seating, solid ash wood legs



MD/2C60_140*

Upholstered modular seating, aluminium baseboard, single / double / triple / quadruple curved unit 60°

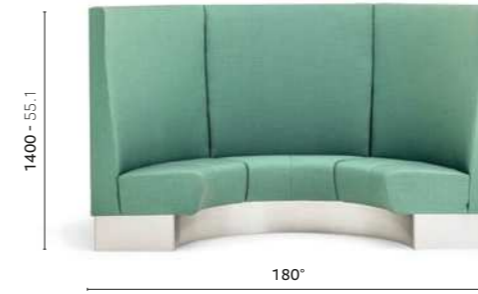

K_MD/2C60

Back curved shelf only, thickness 4cm, single / double / triple / quadruple curved unit 60°
Mensola posteriore per panca curva singola / doppia / tripla / quadrupla raggio 60°
THICKNESS: 40 - 1.57

*Free standing / Autoportante

FINISHES / FINITURE

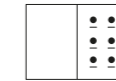

laminate for back side panel / pannello in laminato

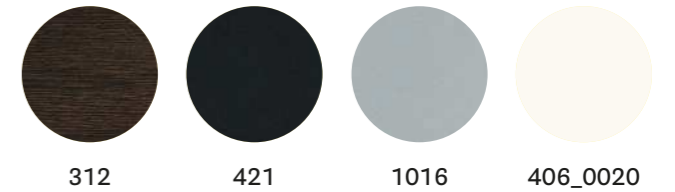

laminate for back shelf / mensola in laminato

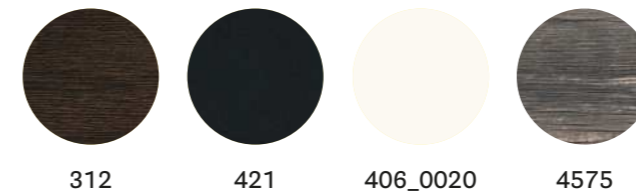

Fenix for back shelf / mensola in Fenix

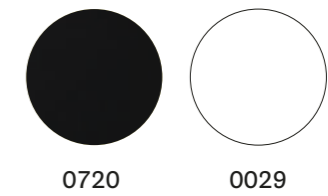

aluminium for baseboard / alluminio per zoccolo

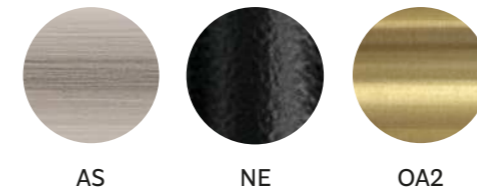

solid ash wood legs / gambe in massello di frassino



CERTIFICATIONS / CERTIFICAZIONI

Omologation "Classe 1 IM" / Omologazione "Classe 1 IM"